







P.169bis

Caratteristiche - Features

-  ABS termoresistente - Thermoresistent ABS
-  Diffusore aria per sbrinatoria vetri - Air diffuser for glass defrosting
-  Secondo codice - According to item code
-  100 pezzi - pieces
-  12,7 dm³
-  2.000 g
-  **T** Sezione tecnica - Technical section pag. 33 - 54



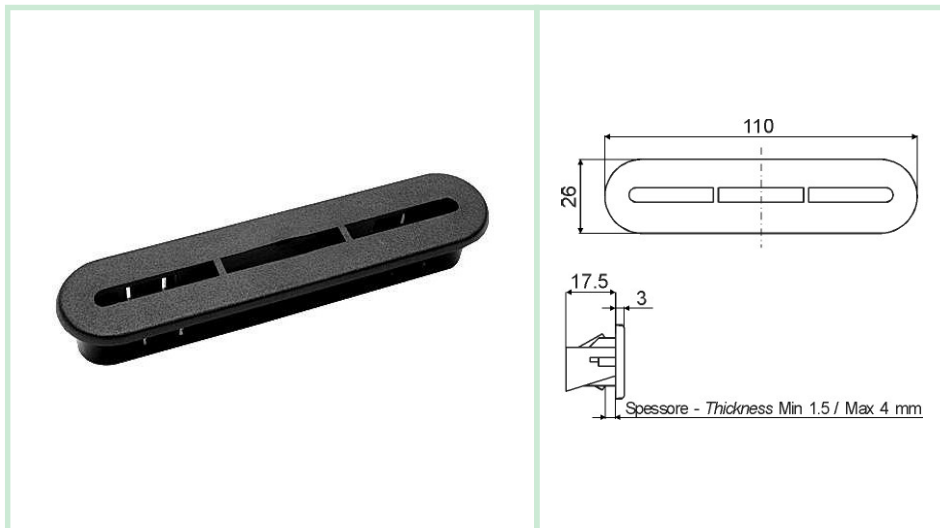





Versioni disponibili / Available versions

| P.169bis | Cod. | Colore - Colour |  |  |  |
|----------|-------|------------------------|---|---|---|
| | 64007 | nero - black | | | • |
| | 67509 | grigio - grey Ral 7012 | | | • 1000 |



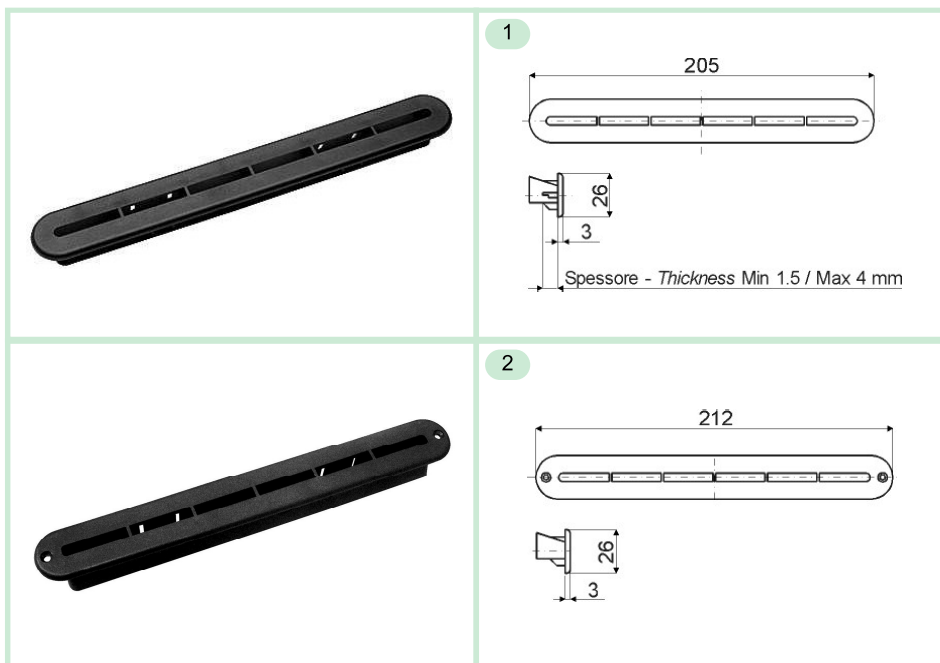

P.169

Caratteristiche - Features

-  ABS termoresistente - Thermoresistent ABS
- 
 1. Diffusore aria per sbrinatoria vetri senza fori di fissaggio - Air diffuser for glass defrosting without fastening holes
 2. Diffusore aria per sbrinatoria vetri con fori di fissaggio - Air diffuser for glass defrosting with fastening holes
-  Secondo codice - According to item code
-  100 pezzi - pieces
-  24,3 dm³
-  Secondo codice - According to item code
-  **T** Sezione tecnica - Technical section pag. 33 - 54



Versioni disponibili / Available versions

| P.169 | Cod. | Tipo - Type | Colore - Colour |  |  |  |  |
|-------|-------|-------------|------------------------|---|---|---|---|
| | 64017 | 1 | nero - black | 3.200 | • | | |
| | 63459 | 1 | grigio - grey Ral 7012 | 3.200 | • | | |
| | 63919 | 2 | nero - black | 3.400 | • | | |
| | 64929 | 2 | grigio - grey Ral 7012 | 3.400 | • | 500 | |