







P.235

Caratteristiche - Features

-  Carcassa e diffusori aria in ABS
Body and air diffuser in ABS
-  Plancia con diffusori aria orientabili
Multiset with adjustable air diffusers
-  Nero - Black
-  50 pezzi (viti non incluse, coprivite ND)
50 pieces (screws not included, screws cover ND)
-  64 dm³
-  6.500g
-  **T** Sezione tecnica - *Technical section*
pag.80

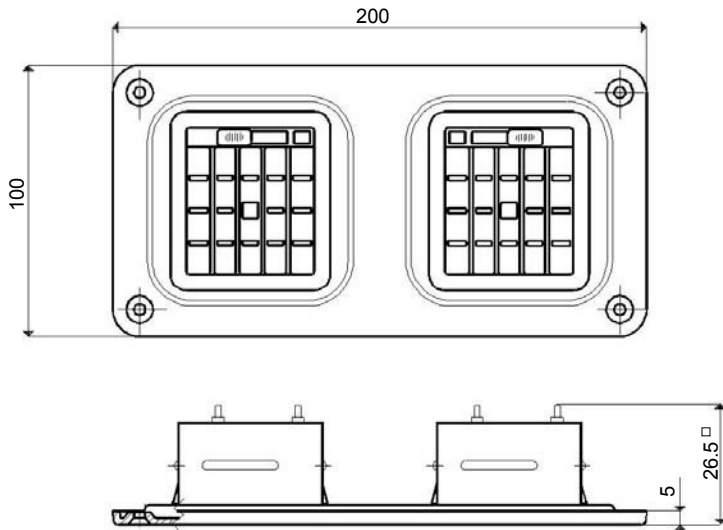
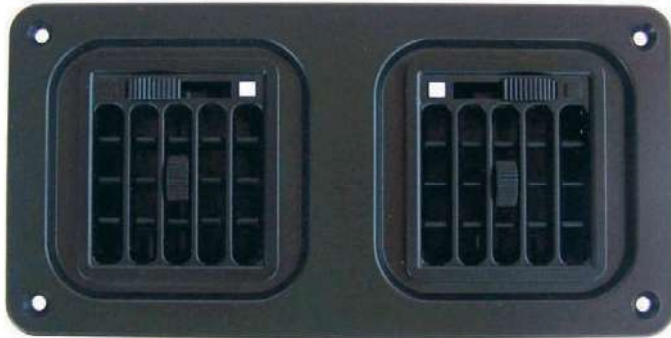

□ = ingombro max con cablaggio / max overall dimension with wiring

Versioni disponibili / Available versions

P.235			
Cod.			
67467			

ND = non disponibile / not available

Caratteristiche tecniche / Technical features

P.235

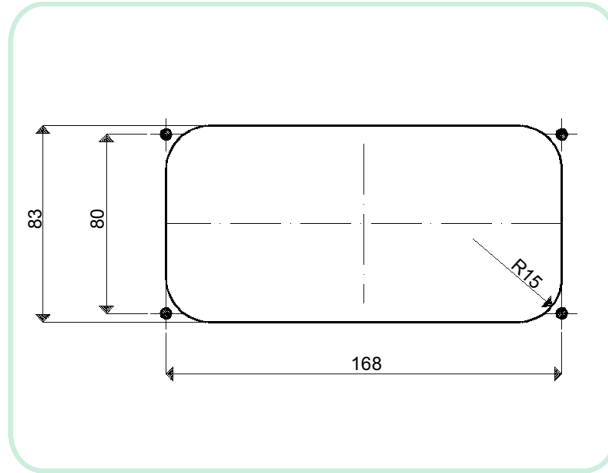

Dima di foratura
Drilling template



Fissaggio - Fixing
viti autofilettanti Ø 3,9 mm a testa svasata (non comprese nella confezione) fori di fissaggio da dimensionarsi a seconda del materiale del supporto.

Ø 3,9 mm countersunk head autothreading screws (not included in the package), fixing holes to be dimensioned according to the material of the support.

Caratteristiche diffusori aria / Air diffusers features

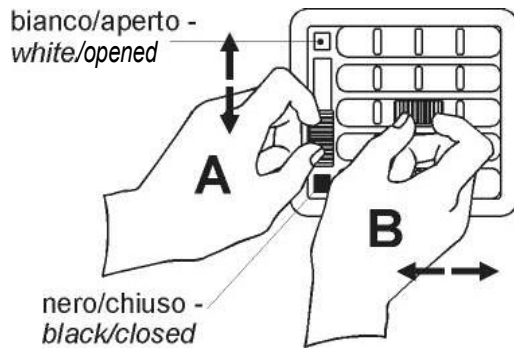

A Parzializzazione, chiusura e orientamento flusso aria
Air flow choking, closing and adjustment
B Orientamento flusso aria
Air flow adjustment

Caratteristiche - Features



Sezione utile passaggio aria: 1.000 mm²
Open air flow section: 1.000 mm²



Temperatura di esercizio: +10/70°C
Working temperature: +10/70°C



Comportamento alla fiamma conforme dir.95/28/EC-
Behaviour under flame agree to 95/28/EC directive