









# P.140

Versione Sx - LH Type



## Caratteristiche - Features





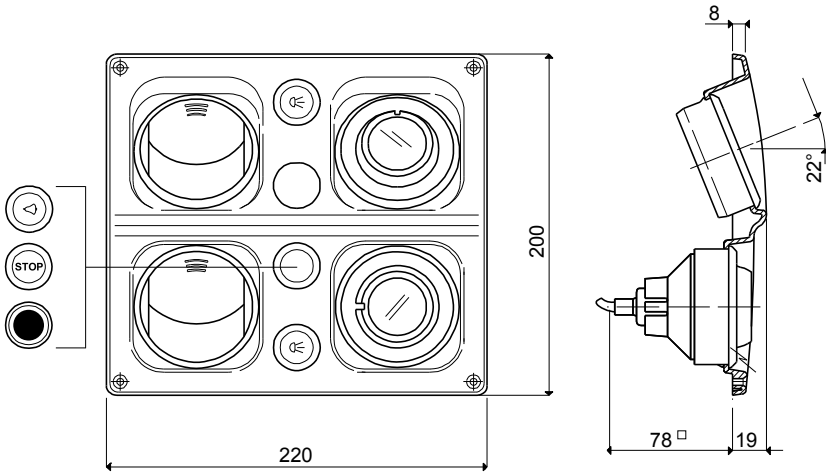





-  Carcasa in ABS, diffusori aria e luce in PA6, vetrino di protezione luci in policarbonato  
*Body in ABS, air and light diffusers in PA6, light protection in polycarbonate*
-  Plancia multifunzione, diffusori aria e luci orientabili  
*Multiset for rack, adjustable air and light diffusers*
-  Secondo codice - *According to item code*
-  10 pezzi (viti non incluse, coprivite ND)  
*10 pieces (screws not included, screw covers ND)*
-  95,7 dm<sup>3</sup>
-  Secondo codice - *According to item code*
-  2,3,4,6,8, (pag. 42)
-  8,10,11 (pag. 42)
-  Sezione tecnica - *Technical section* pag. 56-57

Versione Sx - LH Type





□ = ingombro max con cablaggio / max overall dimension with wiring

## Versioni disponibili / Available versions

P.140													
Cod.		Versione / Version	 Tipo / Type BA 15S										
68141	Nero / Black	Dx - RH	NI (max 10W)	•				•	6.000		•	20	
65652		Sx - LH		•						•			
68312		Dx - RH		•	*						•		
68302		Sx - LH		•	*						•		
65902		Dx - RH		•	**						•		
65572		Sx - LH		•	**						•		
66657		Dx - RH		•	***						•		
66667		Sx - LH		•	***						•		
68352		Dx - RH								•			•
68342		Sx - LH								•			•
64969	Grigio / Grey Ral 7043	Dx - RH	NI (max 10W)	•			•	•	6.000		•	20	
64959		Sx - LH		•			•			•			
<b>P.140V0</b>	<b>materiale autoestinguente / self-extinguishing material</b>												
65942	Nero / Black	Dx - RH	NI (max 10W)	•				•	6.000		•	20	
65932		Sx - LH		•						•			
68372		Dx - RH		•			•				•		
68362		Sx - LH		•			•				•		

 \* = pulsante rosso chiamata Hostess / red hostess call push-button

 \*\* = interruttore rosso chiamata Hostess / red hostess call switch

 \*\*\* = interruttore nero chiamata Hostess / black hostess call with light switch

NI = non incluso / not included  
ND = non disponibile / not available

Caratteristiche tecniche / Technical features

P.140

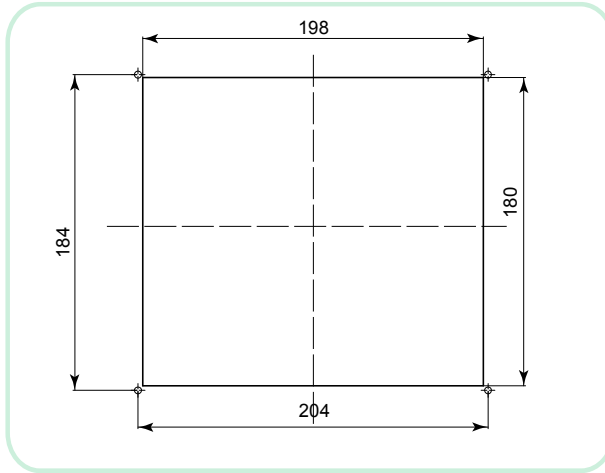

Dima di foratura  
Drilling template



Fissaggio - Fixing  
viti autofilettanti Ø 3,9 mm a testa svasata (non comprese nella confezione) fori di fissaggio da dimensionarsi a seconda del materiale del supporto.

Ø 3,9 mm countersunk head autothreading screws (not included in the package), fixing holes to be dimensioned according to the material of the support.

Caratteristiche diffusori aria / Air diffusers features

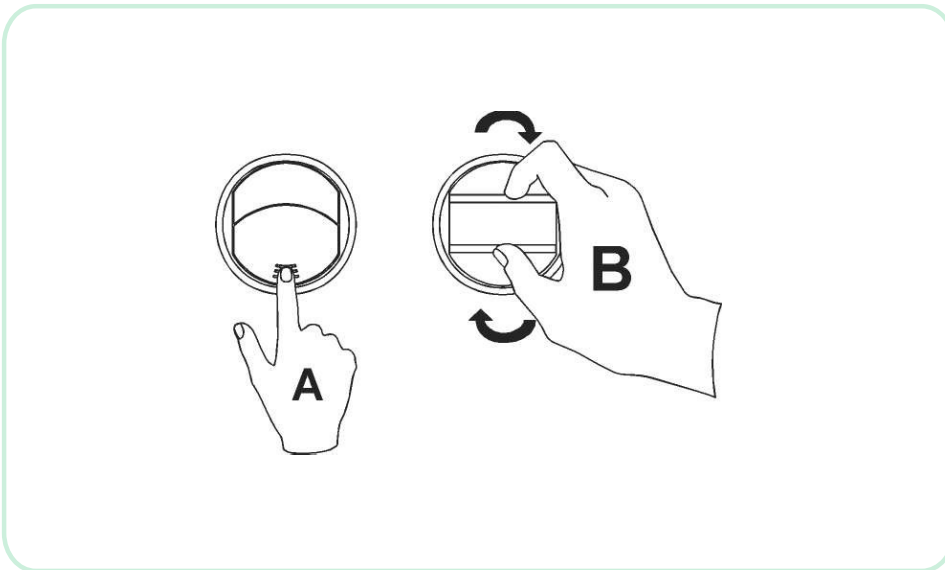

A Parzializzazione, chiusura e orientamento flusso aria  
Air flow choking, closing and adjustment  
B Orientamento flusso aria  
Air flow adjustment

Caratteristiche - Features



Sezione utile passaggio aria: 2.280 mm<sup>2</sup>  
Open air flow section: 2.280 mm<sup>2</sup>



Temperatura di esercizio: -10/120°C  
Working temperature: -10/120°C



Comportamento alla fiamma conforme dir.95/28/EC-  
Behaviour under flame agree to 95/28/Ec directive

P.140

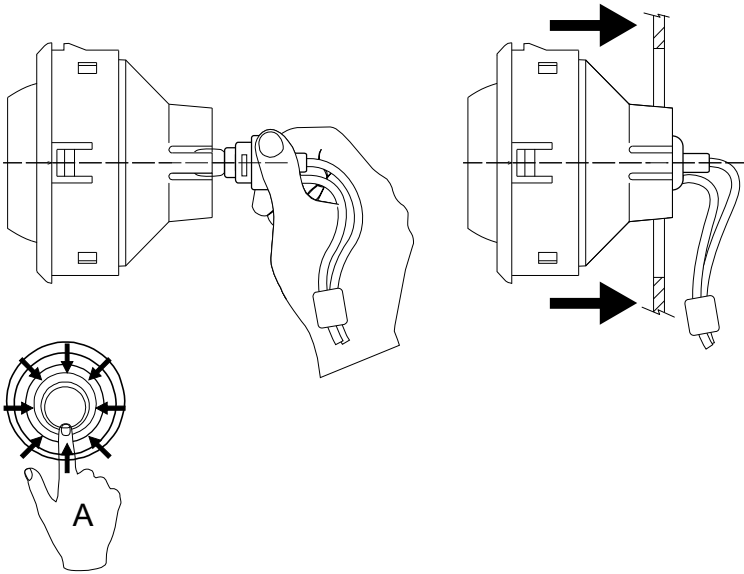

Il multiset viene fornito privo di lampadine, scegliere tra quelle al punto 11 a Pag 42 e assemblarle come fig. a lato. Per cambiare una lampadina bruciata è necessario smontare il Multiset, togliere il portalamпада dalla sede del gruppo luce poi svitare la lampadina e sostituirla (BA15S 24V o 12V Max 10W)

*The Multiset is supplied without bulbs; choose them from amongst the ones listed at item 11 on page 42, and assemble them as shown. To replace a burnt out bulb, remove the multiset and the lamp holder from the light unit seat; unscrew the bulb and replace it (BA15S 24V or 12V Max 10W)*



Temperatura di esercizio: -10/120°C  
Working temperature: -10/120°C



Comportamento alla fiamma conforme dir.95/28/CE  
Behaviour under flame agree to 95/28/EC directive



12 - 24 Volt.



Lampadina / Bulb Max 10Watt

Caratteristiche cablaggi / Wirings features

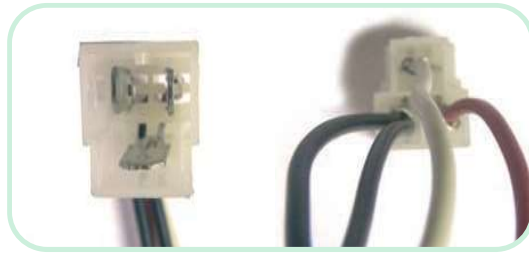

Valido solo per codice  
Available only for cod.:

- 68141
- 65652
- 64969
- 64959
- 65942
- 65932

Valido solo per codice  
Available only for cod.:

- 68312
- 68302
- 65902
- 65572
- 66657
- 66667
- 68362
- 68372

Prova intensità luminosa:

Condizioni: lampada tipo BA15S - 10Watt  
alimentazione 24 Volt D.C.  
Rilevamento dati con Luxmetro digitale ad una distanza della sorgente luminosa di 700 mm

Light intensity test:

Conditions: bulb type BA15S - 10Watt  
power supply: 24 Volt D.C.  
The test was made with digital Luxmeter at distance of 700 mm from light source

