

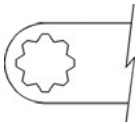

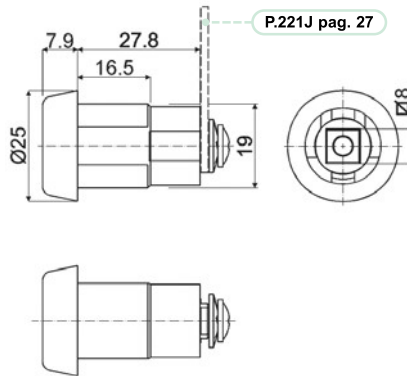





P.53J





Particolare P.221J-
P.221J detail





Caratteristiche - Features

-  Acciaio - Steel
-  -
-  50 pezzi - pieces
-  7 dm³
-  2.400 g
-  -
-  P474 pag. 25 - P221J pag. 27
-  Sezione tecnica - Technical section pag. 30 - 55 - 61

Versioni disponibili / Available versions







P.53J	J ₁		
	Cod.		
	65639		•

P.53J	J ₂		
	Cod.		
	68541		•



P.474 (solo sistemi J.o.k. - only J.o.k. systems)









Caratteristiche - Features



-  Zn+Al+Mg alloy
-  -
-  25 pezzi - pieces
-  0,858 dm³
-  750 g
-  18 (pag. 29)
-  pag. 55 "J.O.K. System" Sezione tecnica - Technical section pag. 30 - 55 - 56 - 57 - 58 - 59 - 60 - 61

Versioni disponibili / Available versions

P.474	Key		
	Cod.		
A1 - 137	63999		•
A2 - 146	64009		•
A3 - 150	64019		•
A4 - 124	64029		•
A5 - 501	64039		•
A6 - 502	64049		•
A7 - 250	64059		•
A8 - 262	64069		•
A9 - 269	64079		•
A10 - 278	64089		•

P.474	Key		
	Cod.		
A11 - 156	64099		•
A12 - 142	64109		•
A13 - 503	64119		•
A14 - 504	64129		•
A15 - 505	64139		•
A16 - 506	64149		•
A17 - 507	64159		•
A18 - 508	64169		•
A19 - 509	64179		•
A20 - 510	64189		•

P.474	Key		
	Cod.		
A21 - 511	64199		•
A22 - 512	64209		•
A23 - 513	64219		•
A24 - 514	64229		•
A25 - 515	64239		•
A26 - 516	64249		•
A27 - 517	64259		•
A28 - 518	64269		•
A29 - 519	64279		•
A30 - 520	64289		•

P.474	Key		
	Cod.		
A31 - 521	64299		•
A32 - 522	64309		•
A33 - 523	64319		•
A34 - 524	64329		•
A35 - 525	64339		•
A36 - 526	64349		•
A37 - 527	64359		•
A38 - 528	64369		•
A39 - 529	64379		•
A40 - 530	64389		•

PS200	69209		•
-------	-------	--	---