

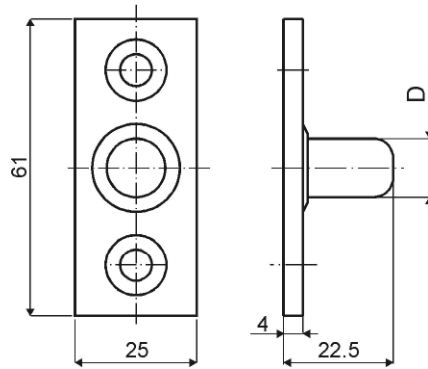











P.70bis



Caratteristiche - Features

-  Acciaio zincato - *Zinc-plated steel*
-  Perno di riscontro: $\varnothing 10$ mm per serr. tipo P62
 $\varnothing 12$ mm per serr. tipo P.70
*Control pin: $\varnothing 10$ mm for P62
 $\varnothing 12$ mm for P.70*
-  50 pezzi - *pieces*
-  2,76 dm³
-  Secondo codice - *According to item code*
-  -
-  Sezione tecnica - *Technical section*
pag.24 - 42(A9-A10) - 43

Versioni disponibili / Available versions

P.70bis	perno di riscontro - control pin			
	Cod.	D		  
	64548	$\varnothing 10$ mm	2.800	•
	64981	$\varnothing 12$ mm	3.020	•

P.130

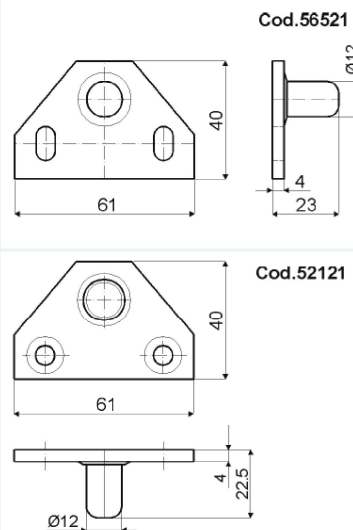

Caratteristiche - Features

-  Acciaio zincato - *Zinc-plated steel*
-  Perno di riscontro per P.70 -
Control pin for P.70
-  50 pezzi - *pieces*
-  2,76 dm³
-  3.600 g
-  -
-  Sezione tecnica - *Technical section*
pag.24 - 42(A9-A10) - 43

Versioni disponibili / Available versions

P.130	perno di riscontro - control pin		
	Cod.	Tipo - Type	  
	52121	con fori - <i>with holes</i>	•
	56521	con asole - <i>with slotted holes</i>	•

P.70bis

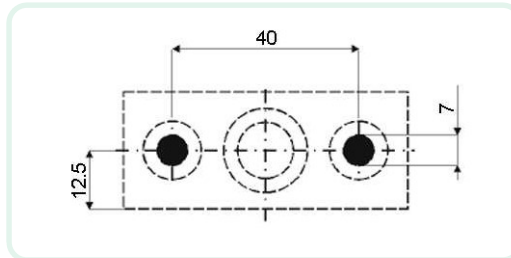

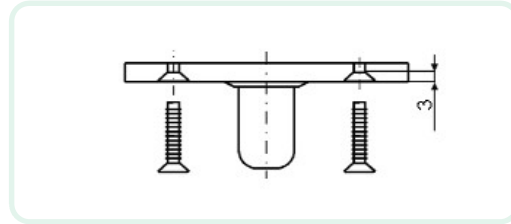

 Dima di foratura
Drilling template



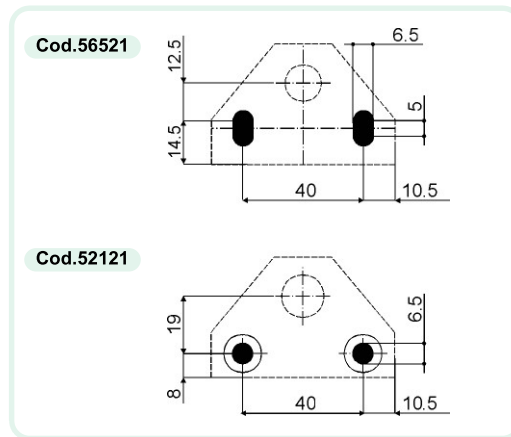

 Per il fissaggio, utilizzare viti M6 testa svasata (materiale non compreso nella confezione)
To attach the control pin, use M6 flathead screws (material not included in the package)

P.130

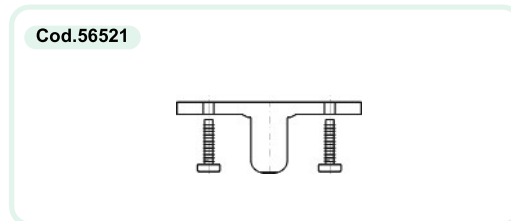

 Dima di foratura
Drilling template



 Cod.56521: utilizzare viti M6
Cod.52121: utilizzare viti M6 testa svasata (materiale non compreso nella confezione)
Cod.56521: use M6 screws
Cod.52121: use M6 flathead screws (material not included in the package)

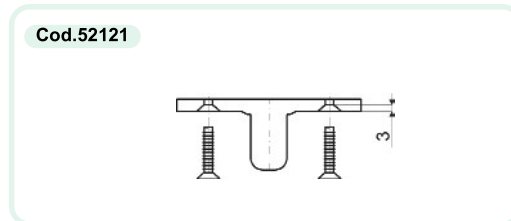

P.238

