

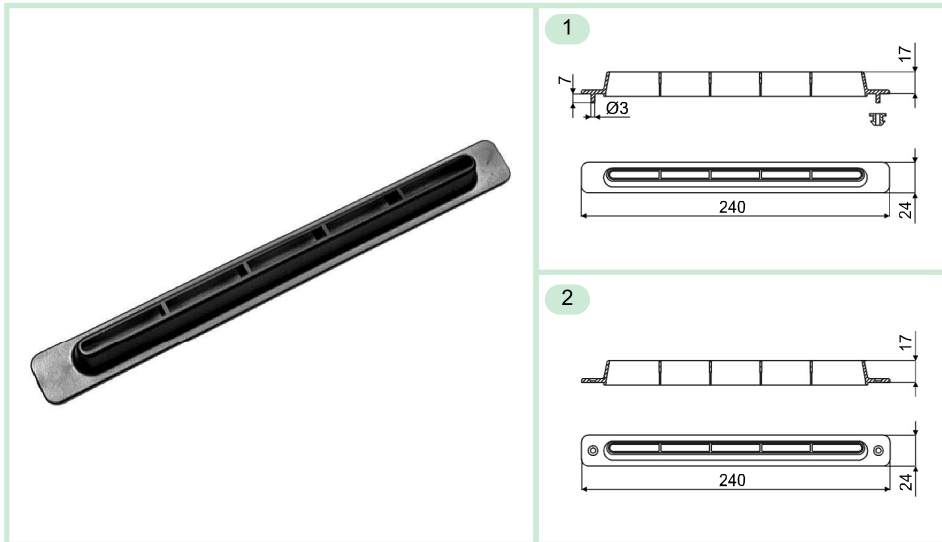











P.168



Caratteristiche - Features

-  ABS termoresistente - Thermoresistent ABS
-  Diffusore aria per sbrinatoria vetri - Air diffuser for glass defrosting
-  Nero - Black
-  100 pezzi - pieces
-  24,3 dm³
-  2.900 g
-  5 pag.32
-  Sezione tecnica - Technical section pag. 33 - 55





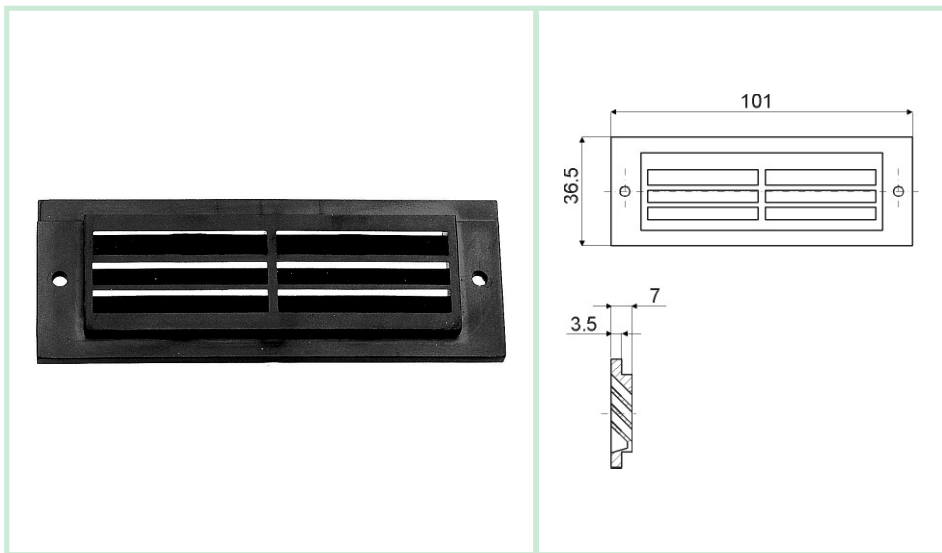

Versioni disponibili / Available versions

P.168	Cod.	Tipo - Type			
	63987	1 con boccole - with bushes			•
	69459	2 con fori e viti - with holes and screws			• 500



P.81



Caratteristiche - Features

-  Secondo codice - According to item code
-  Diffusore aria - Air diffuser
-  Secondo codice - According to item code
-  100 pezzi - pieces
-  7 dm³
-  1.400 g
-  Sezione tecnica - Technical section pag. 33 - 56

Versioni disponibili / Available versions

P.81	Cod.	Colore - Colour	Materiale - Material			
	51870	nero - black	ABS			•
	66367	grigio - grey Ral 7015	ABS			• 1000
	65041	grigio - grey Ral 7001	PA6 + fibra vetro - PA6 + glass fibre			• 1000



Cod.63987 - 69459

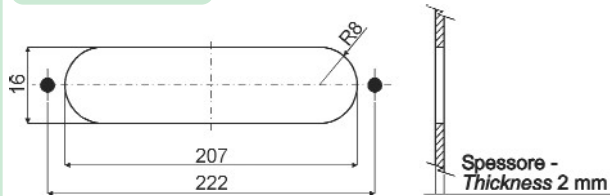

Dima di foratura
Drilling template



Fissaggio - Fixing:
Cod.63987: boccole di fissaggio (comprese nella confezione); fori di fissaggio da dimensionarsi a seconda del materiale del supporto -

Fixing bushes (included in the package) fixing holes to be dimensioned according to the material of the support

Cod.69459: viti autofilettanti $\varnothing 5$ mm a testa svasata (non comprese nella confezione); fori di fissaggio da dimensionarsi a seconda del materiale del supporto -

$\varnothing 5$ mm countersunk head autothreading screws (not included in the package); fixing holes to be dimensioned according to the material of the support

Cod.63987- fissaggio tipo 1 / fixing solution 1

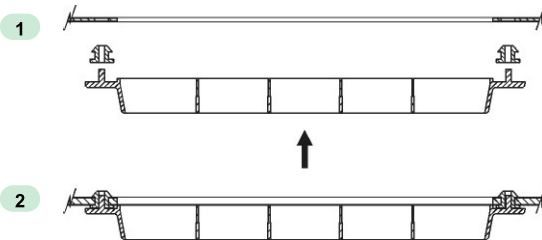

Cod.63987- fissaggio tipo 2 / fixing solution 2

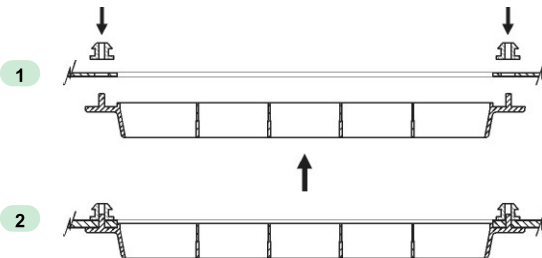

Cod.69459

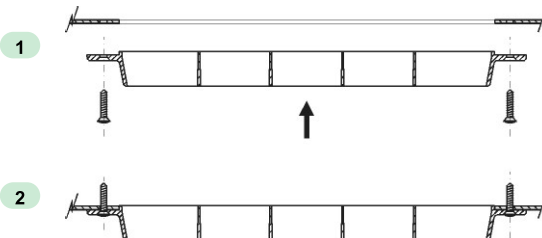

Caratteristiche - Features



Sezione utile passaggio aria -
Open air flow section: 1.100 mm²



Temperatura di esercizio -
Working temperature: 0 / 70°C



Comportamento alla fiamma: conforme dir. 95/28/EC -
Behaviour under flame: agree to 95/28/EC directive